

INSTRUCTIONS FOR THE USE AND CARE OF ZANUSSI WASHING MACHINES

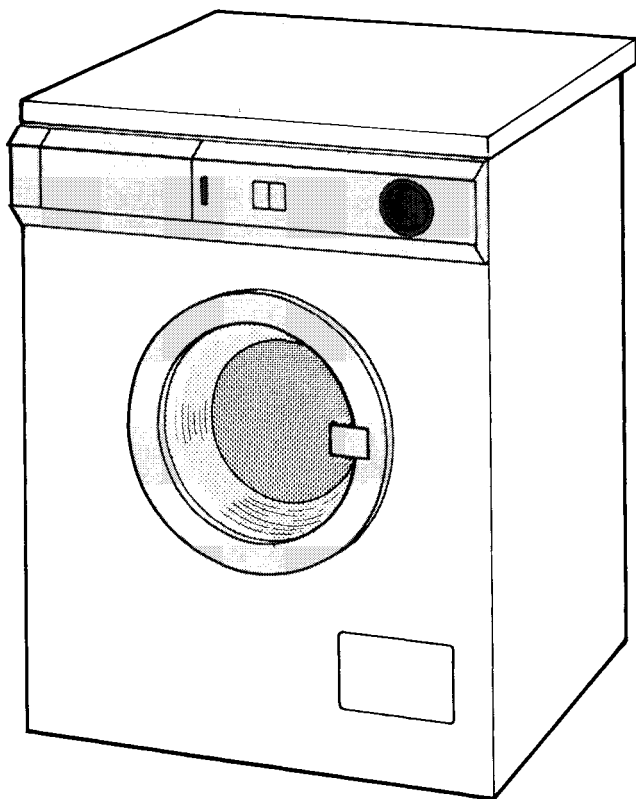

MODEL NO'S FL 812

ZANUSSI
The appliance of science

It is most important that this instruction book should be retained with the appliance for future reference. Should the appliance be sold or transferred to another owner, or should you move house and leave the appliance, always ensure that the book is supplied with the appliance in order that the new owner can be acquainted with the functioning of the appliance and the relevant warnings.

Warnings - Washing Machines

THESE WARNINGS ARE PROVIDED IN THE INTEREST OF SAFETY. YOU MUST READ THEM CAREFULLY BEFORE INSTALLING OR USING THE APPLIANCE.

This appliance is designed to be operated by adults. Children should not be allowed to tamper with the controls or play with the product.

It is dangerous to alter the specifications or attempt to modify this product in any way.

Any electrical work required to install this appliance should be carried out by a qualified or competent person.

Any plumbing work required to install this appliance should be carried out by a qualified plumber or competent person.

This product should be serviced by an authorised Zanussi Network Service Centre, and only genuine Zanussi spare parts should be used.

Care must be taken to ensure that the appliance does not stand on the electrical supply cable.

Always unplug the appliance and turn off the water after use.

Do not overload the appliance. See relevant section in instruction book.

Always look through the glass door to check if water has drained before opening the door. If water is present do not open door before draining the water. If in doubt, refer to your instruction book.

This appliance is heavy. Care should be taken when moving it.

All packing and transit bolts must be removed before use. Serious damage can

occur to the product and to property if this is not adhered to. See relevant section in instructions.

The glass door becomes very hot during the washing cycle. Keep children away from the vicinity of the appliance whilst it is in operation.

Leave the porthole door slightly ajar between washes to preserve the door seal.

Do not overload the appliance. See relevant section in instruction book.

Only wash fabrics which are designed to be machine washed. If in doubt, consult the manufacturer of that item.

Before washing, ensure that all pockets are empty and buttons and zips are fastened. Avoid washing frayed or torn articles and treat stains such as paint, ink, rust, and grass before washing. Underwired bras must not be machine washed.

Any objects such as coins, safety pins, nails, screws, stones or any other hard, sharp material can cause extensive damage and must not be placed into the appliance.

Garments which are saturated with petroleum products should not be machine washed. If volatile cleaning fluids are used, care should be taken to ensure that the fluid is removed from the garment before placing in the machine.

Wash small items such as socks, laces, washable belts etc in a washing bag or pillow case as it is possible for such items to slip down between the tub and the inner drum.

Only use the advised quantities of fabric softener. Damage to the fabric can ensue if you over-fill. Refer to the manufacturers' recommendations of quantities.

Pets have been known to climb into washing machines. Please check your drum before use.

Under no circumstances should you attempt to repair the machine yourself. Repairs carried out by inexperienced persons may cause injury or more serious malfunctioning. Contact your local Zanussi Network Centre. Always insist on genuine Zanussi spare parts.

Contents

Page 7	Installation
Page 12	Getting to know your machine
Page 18	Using your machine
Page 21	Additional programmes
Page 22	Looking after your machine
Page 24	Helpful washing hints
Page 25	How to wash...
Page 27	Servicing
Page 28	ZANUSSI Guarantee conditions
Page 29	ZANUSSI 5 year cover

Please note that the specifications of your appliance may differ slightly from those shown in this leaflet.

Specifications

FL 812

Dimensions

Height	850mm 33.5"
Width	600mm 23.6"
Depth	550mm 22.7"
Weight	176lb 80kg
Capacity	10lb 4.5kg
Revolutions per minute	400/800

Power Absorbed	2730W
Heater Rating	2300W
Motor Rating	
Wash	430W
Spin	450/650W
Voltage	220/240V
Frequency	50Hz

Water Load

Normal	2.9 gals 13 litres
High	4.4 gals 20 litres

Pressure psi

Maximum	110
Minimum (hot)	4
Minimum (cold)	7

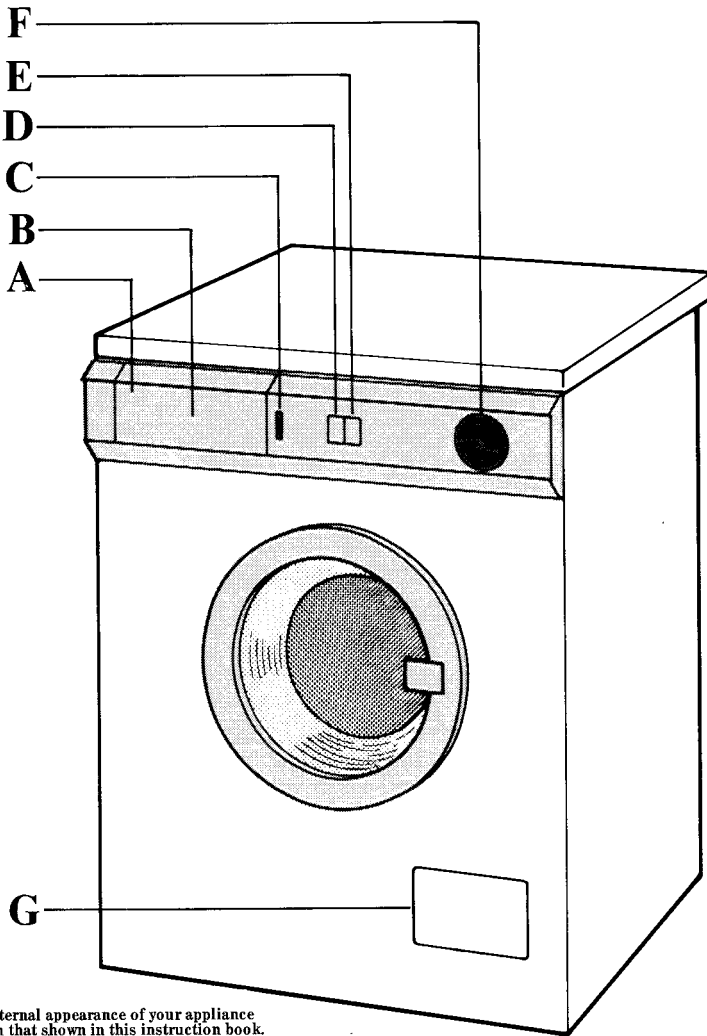

Please note that the external appearance of your appliance may differ slightly from that shown in this instruction book.

- A - Programme chart
- B - Detergent dispenser (handle)
- C - Pilot light
- D - Half load button $\frac{1}{2}$
- E - Economy button \square
- F - Programme control and on/off control
- G - Drain filter

Installation

Unpacking

Having removed the outer carton, reinforcing angles, and polythene wrapping, you must take out the internal packing which protected the appliance's 'works' during transit.

1
Using the plastic spanner provided, remove the three large bolts from the back of the machine to free the washing drum (figure 1).

2
Each bolt leaves behind a plastic spacer inside the machine, this should be worked loose by inserting a screwdriver into the bolt hole, allowing the spacer to drop to the bottom of the machine.

3
Lay the machine carefully on its back to reveal two pieces of polythene bands in the base (figure 2).
First pull band A, on left hand side then pull band B on the right hand side to withdraw the remaining internal packing, taking care not to catch and damage any of the appliance's internal components in the process.

4
Finally, lift the appliance off the polystyrene base packing and remove the plastic spacers you worked loose earlier. These spacers, together with the three large bolts and other internal packing should be kept in a safe place so they can be used if the machine has to be transported again.

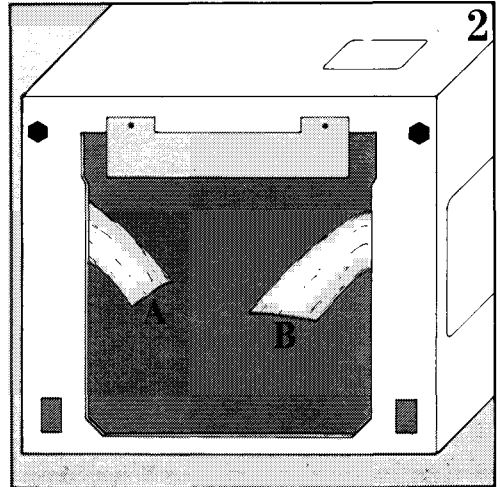
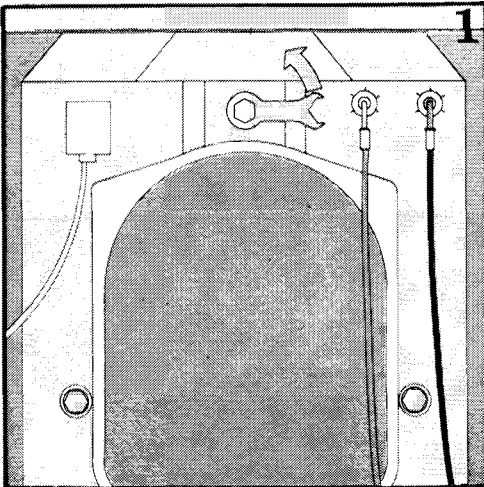

Positioning and levelling

To keep vibration, noise and movement to a minimum, it is essential that the machine is absolutely level. Check this with the aid of a spirit level when the machine is in its permanent operating position. Any adjustments needed can be made by using the open end of the spanner supplied to raise or lower the two adjustable feet at the front of the machine – you merely screw them up or down (figure 3).

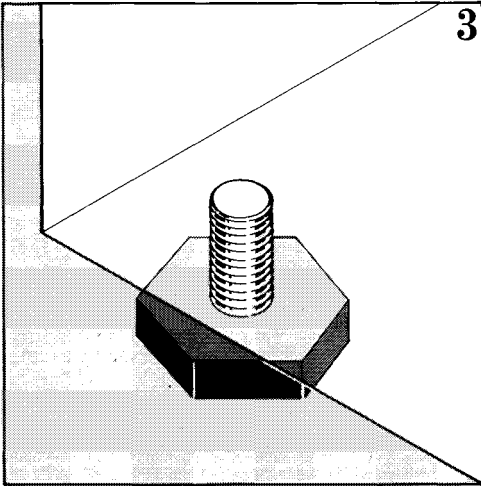

Some vibration is inevitable, especially if mounted on a wooden floor.

Please ensure that when the appliance is installed it is easily accessible for the engineer in the event of a breakdown.

Plumbing

Your new Zanussi washing machine has been designed to be permanently plumbed in to your home's water supply and drainage system. However, if this is not possible, it may be connected to suitable existing taps, with the drain hose discharging into a sink.

The appliance has two inlet valves, hot and cold, with female 3/4" BSP thread connectors. If this connection size is not compatible with the plumbing of the existing installation, a variety of connectors are available from good hardware stores and plumbers merchants to suit most domestic plumbing. Any alterations to your existing plumbing must be carried out by a competent person, or qualified plumber.

The inlets on the back of the appliance are colour coded, blue for cold, red for hot. Before connecting the hoses be sure to fit the mesh filters supplied as per diagram.

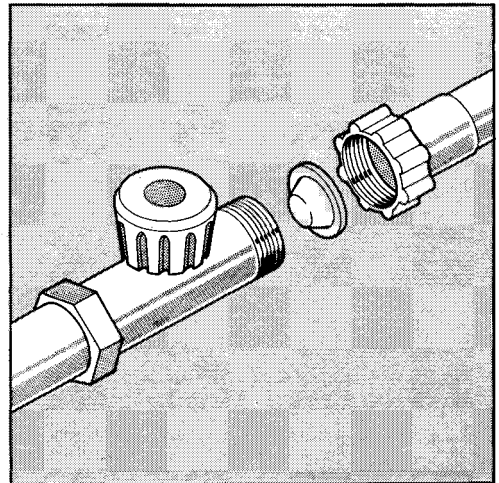

If only a cold water supply is available, connect the two hoses to a cold water outlet by means of a "Y" connection piece.

Installation should comply with local water authority and building regulations' requirements.

The appliance must be given a separate cold water supply and not be connected to a mixer tap, a single outlet water heater or a booster pump. A minimum water pressure of 7 psi is required for the safe operation of the appliance.

If you cannot make the cold water connection direct from the rising mains, you may be able to operate the appliance from your cold water storage system. There should be a minimum distance of 5.02 m (16.5 ft) between the appliance's inlet and the bottom of the tank.

There will be sufficient pressure for the hot water supply from the hot water cylinder if the height between the appliance's inlet and the bottom of the cold water storage cistern (not between the appliance and hot water cylinder) is at least 2.74 m (9 ft).

If you are operating the appliance on the minimum pressure of 7 psi, it may fill slowly. This flow can be increased by removing the small restrictor contained within the inlet valve. In order to remove the restrictor, first turn the water off and unplug the appliance. Disconnect the water supply hose from the inlet valve, pull out the mesh filter inside the valve. Remove the restrictor (which is a small round washer) with the aid of thin-nosed pliers.
Replace mesh filter and re-fit hose.

If the water supply in your area is hard it is possible that the filters situated in the fill valves can become blocked with sand or limestone deposits and in extreme cases this can cause a breakdown of the fill valves ie: no water fill or continuous filling.

We would suggest that you install supplementary strainers which should be fitted on the fill hoses of your machine. For information about the availability of these supplementary strainers you should contact your local plumber.

If you intend the drain hose from the machine to empty into a sink, make sure the sink is empty and that the plug hole is not blocked.

Where the machine is permanently plumbed in hook the end of the hose into a standpipe installed for the purpose. It should have an internal diameter of at least 38 mm (1½ in) thus leaving an air gap between hose and pipe, and should be designed in such a way that the water level within it never covers the end of the hose.

Important: Before connecting up the machine to new pipework or to pipework that has not been used for some time, run off a reasonable amount of water to flush out any debris that may have collected in the pipes.

Whether discharging into a sink or a standpipe check that the end of the drain hose is neither too high nor too low. The top of the curve in the hose's end should be no more than 85cm (34") and no less than 50 cm (20") above floor level. (figure 4).

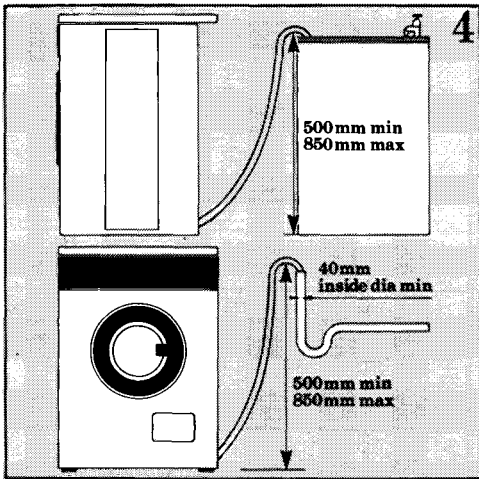

Finally, make sure that with the machine in position, the drain hose is not obstructed, blocked or bent so sharply that water cannot flow freely.

The electrical connections
WARNING:
THIS APPLIANCE
MUST BE EARTHED

The manufacturer declines any liability should this safety measure not be observed.

If the plug that is fitted to your appliance is not suitable for your socket outlet, it must be cut off and the appropriate plug fitted. The cut off plug should be disposed of to prevent the hazard of electric shocks in case it should be plugged into a 13 Amp socket in another part of your home.

IMPORTANT

The wires in this mains lead are coloured in accordance with the following code:

GREEN AND YELLOW - EARTH

BLUE - NEUTRAL

BROWN - LIVE

If you fit your own plug, the colours of the wires in the mains lead of your appliance may not correspond with the markings identifying the terminals in your plug, this is what you have to do: Connect the green and yellow (earth) wire to the terminal in the plug which is marked with the letter «E» or the earth \perp symbol or coloured green, or green and yellow.

Connect the blue (neutral) wire to the terminal in the plug which is marked with the letter «N» or coloured black.

Connect the brown (live) wire to the terminal which is marked with the letter «L» or coloured red.

The plug moulded on to the cord incorporates a fuse. For replacement, use a 13 Amp BS 1362 fuse. Only ASTA approved fuses should be used.

The fuse cover/carrier must be replaced in the event of changing fuse.



The right fuse cover/carrier colour is the one shown by the coloured insert at the base of the plug.

The plug must not be used if the fuse cover/carrier is lost. A replacement cover/carrier must be obtained from Zanussi Service Agents whose addresses are listed on the attached «Zanussi Service Agents Nationwide» or you could find your local agent by looking in your telephone directory under "Z".

This appliance complies with E.E.C. directive no. 82/499 of 7.6.82 relative to radio interference suppression.

Getting to know your machine

The controls and how to use them

- A Programme chart
- B Detergent dispenser
- C Pilot light
- D Half load button 
- E Economy button 
- F Programme control and on/off control
- G Drain filter

A Programme chart.

This chart will help you to select the correct wash programme. The letter and wash programme numbers correspond to those used in the detailed charts on pages 14–17.

B Detergent dispenser

The dispenser has three compartments—two for detergent (**a** and **b**) and one for fabric conditioner (**c**), (see figure 6 page 19).

The fabric conditioner compartment is fitted with a removable filter. To open the dispenser, push back the hinged front, hook your hand around the top edge and pull.

C Pilot light

The pilot light comes on when the machine is set to start.

D Half load button

By pressing this before selecting a wash programme the intake of water is reduced. This is useful if you want to wash half loads, 2kg (4 ½lb) instead of the usual 4.5kg (10lb) of cotton or linen items.

By reducing the water consumption you will use less electricity.

The half load programme is not suitable for synthetic or mixed fabrics, delicate articles or wool. These fabrics all need a high water level to avoid creasing.

E Economy button

By pressing in this push-button prior to selecting wash cycle B or C, you will obtain a reduction of the wash temperature from 95°C to 60°C whilst the duration of the programme will remain practically unchanged.

This will ensure a substantial saving in electricity consumption.

It is advisable to press in this pushbutton particularly when washing strong white fabrics which do not have stubborn stains.

F Programme control and on/off control





The selector dial is marked with letters corresponding to those on the chart.

To set the machine to the correct programme (see programme chart and table on pages 14-17) push the dial in and turn it clockwise until the letter you want coincides exactly with the red pointer at the top of the dial. Never attempt to turn the control dial in an anti-clockwise direction.

To start the machine, pull out the knob. If the knob does not come out easily check that the pointer is in line with the selected letter – if it is not, reset the dial.

To stop the machine during a cycle, push the dial in. At the end of the programme push the knob in and the pilot light will go out. The machine will have stopped automatically.

The symbols around the dial indicate at what stage in the programme the wash has reached:

-  Prewash
-  Main wash
-  Rinses
-  Spin
-  Drain

G Drain filter

This is situated behind the small flap door at the base of the cabinet. It will need cleaning from time to time. (See pages 23).

The washing programme

The washing machine has 12 programmes and 8 additional programmes such as "rinse" or "spin only" (see charts pages 14-17). Each washing programme is designed for a specific type of fabric, for example cotton, nylon mixed fabrics such as polycotton, etc. They follow the International Textile Care Labelling Code (ITCLC) which is used for wash labels on garments and household linen as well as on washing powder packets. This makes it simple to choose the right programme for the fabric you are washing.

The energetic wash cycles for robust fabrics (B-G) are completely automatic taking the clothes through washing, rinsing, spinning and draining.

The Gentle wash cycles (L-S) are for minimum iron, drip dry and delicate fabrics. The machine stops after the last rinse before the water draining and spinning.



The clothes are left suspended in water to prevent them becoming creased by remaining in the bottom of the wash tub in a damp state after spinning.

To complete the cycle, turn the programme selector dial to cycle V for water draining followed by a short spin, or to cycle Z for drain only if you are washing drip dry articles.

Energetic wash cycle

For cotton, linen and viscose (rayon) fabrics

Recommended wash load: 4.5 kg (10lb) max

Wash cycle Position of programme selector	Dispenser compartments		Wash cycle description and fabric guide
	a washing powder	c fabric conditioner	
A Pre-wash	a		Cottons and linens Prewash in water at 40°C (normal level) followed by a soaking phase – the laundry is left soaking in the water. To drain the water, turn the programme knob to cycle V (drain with a gentle spin) or Z (drain only).
B* Whites - heavy soil	a b	c	White cottons and linens without special finishes. Prewash in water at 40°C (normal level). Main wash in water at 95°C (normal level). 4 cold water rinses (high level). Spinning.
 C* Whites	b	c	White cottons and linens without special finishes. Main wash at 95°C (normal level). 4 cold water rinses (high level). Spinning.
D Fast Coloureds - heavy soil	a b	c	Cottons, linens and viscose with special finishes Prewash in water at 40°C (normal level). Main wash in water at 60°C (normal level). 4 cold water rinses (high level). Spinning.
 F Fast Coloureds	b	c	Cotton, linens and viscose with special finishes. Main wash in water at 60°C (normal level). 4 cold water rinses (high level). Spinning.
			

*With these wash programmes you may use the "Economy" pushbutton, if so required. See the relevant paragraph.

Wash cycle Position of programme selector	Dispenser compartments		Wash cycle description and fabric guide
	a b washing powder	c fabric conditioner	
G Non-fast Coloureds 	b	c	Cottons, linens and viscose. Main wash in water at 40°C (normal level). 4 cold water rinses (high level). Spinning.
H Rinses		c	Cottons, linens and viscose. 4 cold water rinses (high level). Spinning.
J Special treatments		c	Cottons, linens and viscose. Intake of water mixed with liquid additive such as fabric conditioner (high level). Special treatments. Spinning.
K Spin only			Spinning for about 6 minutes with simultaneous water draining. This is preceded by slow rotations of the drum.

Water filling

30°/40°/50°C programmes – cold water filling







60°C programmes – hot and cold filling

95°C programmes – hot water filling only.

Should you need to check the water filling temperature, use the above information for guidance.

Gentle wash cycle

For delicates, synthetics including acrylics, acetates, triacetates, machine-washable woollens and synthetics mixed with polyester and wool.
 Recommended wash load: 1.5-2kg (3-5lb);
 wool max: 1kg (2lb)

Wash cycle Position of programme selector	Dispenser compartments		Wash cycle description and fabric guide
	a washing powder	c fabric conditioner	
L White Special cottons 	b	c	Cotton articles with special finishes. ✓ Main wash in water at 95°C (high level). 3 cold water rinses (high level).
M Whites - heavy soil 	a b	c	White nylon and polyester/cotton mixtures Prewash in water at 40°C (normal level). Main wash in water at 60°C (high level). 3 cold water rinses (high level).
N Whites 	b	c	White nylon and polyester/cotton mixtures Main wash in water at 60°C (high level). 3 cold water rinses (high level).
P Minimum Iron 	b	c	Coloured synthetics and mixed fabrics Main wash in water at 50°C (high level). 3 cold water rinses (high level).
Q Delicates 	b	c	Acrylics, acetates, triacetates and wool mixtures Main wash in water at 40°C (high level). 3 cold water rinses (high level).
R Woollens 	b	c	Machine washable woollens and mixtures with cotton or viscose; blankets Main wash in water at 40°C (high level). 3 cold water rinses (high level).

Wash cycle Position of programme selector	Dispenser compartments		Wash cycle description and fabric guide
	a b washing powder	c fabric conditioner	
S Silks 	b	c	Silks and printed acetate fabrics Main wash in water at 30°C (high level). 3 cold water rinses (high level).
T Rinses		c	3 cold water rinses (high level).
U Special treatments		c	Intake of water mixed with liquid additive such as fabric conditioner (high level).
V Short spin only			Water draining followed by a short spin at 400 r.p.m.
Z Drain			Water draining with a steady drum.

Note: There is no water draining after the last rinse of the gentle wash cycles. This prevents the clothes from creasing if they are left in the machine at the end of the wash cycle.

The clothes are held suspended in water until you turn the selector dial to V when the water will be drained and the clothes will be given a gentle spin. Or the selector dial can be turned to Z when the water will drain away without spinning.

Warning

Do not open the machine door until one of the draining programmes has been completed. If you do, there will be a flood.

Using your machine

Sorting the wash

Sort the clothes and households linen according to fabric, colour fastness and degree of soiling, following the charts on pages 14-17. Check with the wash care label sewn to the garment or article; this should have a number in a wash tub symbol which corresponds with the number shown on the charts. For example, if your sheets have a label with number 1 in the wash tub you can choose either programme B or C depending on whether the articles are lightly or heavily soiled. If the garment has no label, choose the appropriate programme for the fabric. If you are uncertain what fabric this is, always choose one of the gentle wash cycles such as P or Q. Be cautious with coloured items unless they are labelled colourfast, wash them separately by hand, or use the programme for non-fast coloureds.

For the best results wash a full load.
4.5kg (10lb) of cottons
1.5-2kg (3-5lb) synthetics
1kg (2lb) machine washable woollens

Until you are familiar with the size of a full load, weigh the articles on the kitchen or bathroom scales. Try to mix large and small items in each load. If you cannot make up a full load of similar items (eg cotton sheets and towels) make up a load of any polycotton and cotton items, and use one of the lower

temperature washes P (50°C).

Remember, however, that white cotton and linen should be washed at higher temperature (95°C) every third wash to keep them a good colour.

The half load programme is also useful, if you cannot make up a full load of cottons and linens.

Loading the clothes

Open the drum loading door by pulling the catch forward (figure 5). Put the sorted clothes into the drum one by one, shaking them out first.

Alternate large and small items.

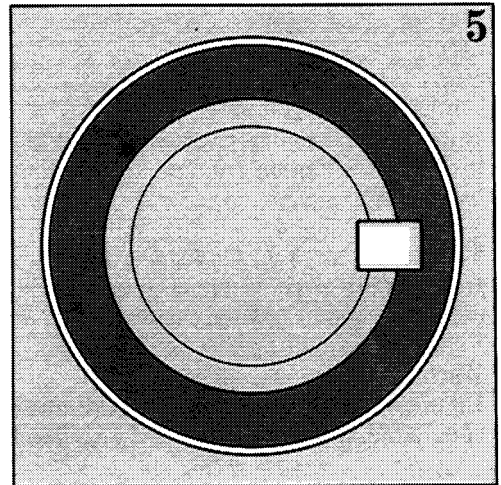

Don't put laundry on the door!

Be sure all pockets are empty, buttons and zips fastened. Avoid washing frayed or torn articles, and treat stains such as paint, ink, rust and grass before washing (see page 28).

Once the machine is loaded close the door firmly. Then put the washing powder and conditioner (if required) into the dispenser.

Choosing the right washing powder

Always use a low lather powder. This is important as too much lather prevents the articles from tumbling freely and being properly cleansed. **Ariel Automatic** is specially designed to complement the cleaning action of the machine.

Filling with washing powder

The washing powder dispenser has three compartments (figure 6). Compartment 'a' is for the prewash powder, 'b' for the main wash powder, and 'c' for fabric conditioner. The same wash powder can be used for the pre and main wash cycles. Pull out the dispenser and add the measured amount of powder, following the directions on the wash powder packet (see also Table which follows). Be sure to use enough powder – this is essential to get the clothes really clean. Once the dispenser is filled, close it by pushing it in gently. This is particularly important if you are using fabric conditioner

because if the drawer is slammed it will cause the conditioner to enter the machine prematurely.

For information regarding the degrees of hardness of water in your area, ask the local Water Authority.

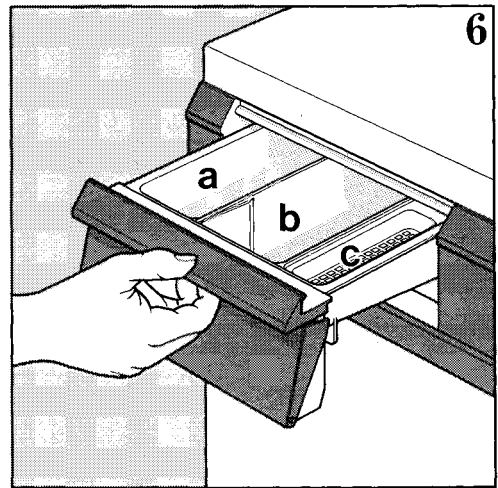

Amount of wash powder in grammes for a full load.

Hardness	Pre-wash	Main wash following pre-wash	Main wash
Soft	30	120	130
Average	60	135	160
Hard	90	185	230
Very hard	125	235	270

For half loads use about 3/4 of quantity.

To allow use of liquid detergents, instead of powder, special dispensers are available.

These accessories are obtainable on request.

Using fabric conditioners

When you want to use a conditioner, put the measured amount (follow manufacturers' instructions) into compartment 'c' in the washing powder dispenser at the same time as you put in the washing powder. **Be careful not to fill the compartment above the level of the filter.** The conditioner will be automatically used by the machine at the appropriate time. Remember to close the drawer (fig. 6) gently.

To start the machine

Check that:
the main switch is on;
the door is properly closed;
the water is turned on.

Select the programme required by pushing in the programme selector dial and turning it clockwise to the required letter. Pull out the knob. The pilot light will then come on and the machine will start. The machine will automatically carry out all the operations up to the end of the chosen programme. Then it will stop. The pilot light will not go out until the selector knob is pushed in to switch the machine off.

If, after the start of a programme, you find you have selected the wrong one, push the selector knob in to stop the machine. Then turn the dial clockwise to the correct positions and pull the knob out to restart the washing cycle.

At the end of the programme push the knob in to switch the machine off.

Unloading the clothes

The drum door remains automatically locked for 1-2 minutes after the machine has been switched off. You can then open the door and unload the machine. **If you have been using a gentle wash cycle do not forget to set the machine to drain the water (programme V or Z) before opening the door.**

Additional programmes

Economy programme

Use this programme for lightly soiled loads of cotton or linen. Press in the pushbutton marked  and then select either programme **B** or **C**.

See page 12.

Half-load programme

Use this for smaller loads of cotton and linen items – 2kg (4lb) max. Press in the pushbutton marked ½, then select the appropriate programme. Do not, however, use any of the gentle action programmes as these need a higher water level, than is allowed for the half-load programme.

See page 12.

Spin only

This programme can be used to remove water from hand washed articles or any laundry which may have got wet but does not need washing. For example, washing left on the line during a rainstorm.

See page 15.

Special treatments

If you want to treat an article with fabric conditioner without washing it first, you can do this on either programme **J** or **U**.

Looking after your machine

Important: Make sure that the machine is unplugged and the water taps turned off before undertaking any kind of maintenance.

General care and cleaning

Wipe round the rubber door seal to remove the water which collects in it.

From time to time clean plated, polished and plastic parts and the glass porthole door with a soft damp cloth. Never use abrasive powders.

Wipe over the exterior cabinet with a lukewarm solution of a mild liquid cleaner, rinse and dry thoroughly. From time to time, apply a little wax furniture cream with a soft cloth.

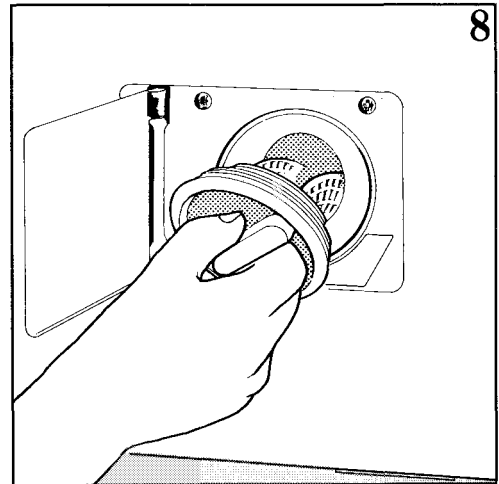
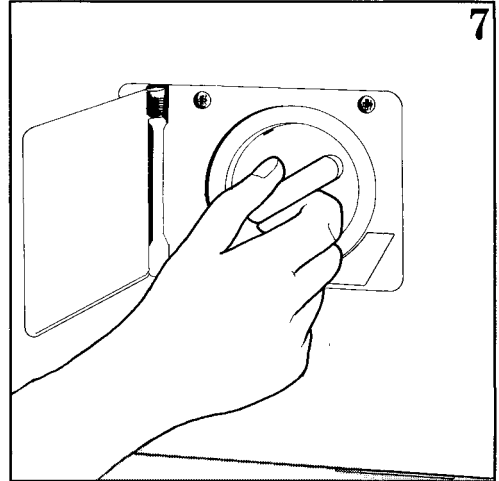

Cleaning the drain filter

(see diagram)

Unscrew and pull out the filter (figure 7-8)

Underneath the filter there is a small extractable gutter which makes it easier to collect any residual water that might flow out when the filter is removed.

Remove any object or fluff and replace the filter.

This filter should be checked after each wash.

Cleaning inlet filters

These are situated at the back of the machine and should be inspected from time to time. Turn off the water taps.

Unscrew the hoses and remove the mesh filter lodged just inside the hose.

Run them under a fast running tap to remove any sediment. Replace the wire filters and the hoses firmly.

Cleaning the washing powder dispenser

Wipe it out after every wash.

From time to time it will need more thorough cleaning to clear out all the deposit. Remove the drawer completely with a sharp pull outwards. When you replace it, if you find that it doesn't slide right in again give it a sharp tap with the palm of your hand.

Helpful tips for successful washing

Here are some practical hints to help you get the best washing results.

Don't overload the machine. The clothes will not move around freely and the washing powder may not dissolve properly.

Always use a low lather washing powder specially made for front loading machines. Excessive foaming gives an unsatisfactory wash and may even harm the machine. The quantity of washing powder required depends on the amount of laundry and how soiled it is. It may therefore be necessary to vary the quantities suggested on page 20. You will be able to tell if you need to do this when you are used to the machine.

Don't put washing powder into the dispenser until just before starting a programme. If the powder is left for any length of time in the dispenser it may form lumps which are difficult to dissolve.

For best results do not wash more than 1kg (2lb) of woollen articles at a time.

Wash only woollen articles marked 'machine washable'.

For best results do not wash more than 1.5-2kg (3-5lb) of synthetic fabrics in one load. Synthetic fabrics need plenty of room to move around or they tend to crease.

Clothes should be sorted according to the fabric – colour fastness and degree of soiling (see page 18).

Mend open seams and tears before washing.

Close zips, secure buttons.

Collect laces, washable belts socks, etc and put them in a bag for washing.

Empty pockets. **(This is important as should a coin become lodged between the tub and drum it can cause extensive damage). See final paragraph page 27.**

Remove spots of rust, paint, ink and grass stains before washing (see instructions page 26).

Don't wash light coloured fabrics with dark ones. One may leave specks of fluff on the other.

Don't risk washing coloured articles unless you are sure they are colourfast. It's worth hand washing the article to find out.

If you live in a hard water district, you can add water softening powder to the washing machine in compartment 'b'. For the quantity of water softener to use, see packet directions.

How to wash

Nappies

Leave the soiled nappies soaking in a solution of proprietary nappy cleaner. When there are sufficient for a wash, drain off the water and rinse by hand in cold water (this is advisable as some nappy cleansers have an adverse effect on the rubber door seal), then transfer the nappies to the washing machine. Set the selector dial to programme K (fast spin) to remove excess solution. Then wash the nappies on programme C (whites). Dry and air them thoroughly.

Blankets

Only wash blankets which are labelled as suitable for machine washing. Use wash programme R (woollens) followed by programme V (drain and spin) which will remove the excess water and leave the blanket ready to tumble dry or hang out on a line.

Curtains

Check that the fabric is washable. Remove all the curtain hooks and if the heading is drawn up by means of curtain tape, release the strings to allow the fabric to spread flat. Weigh the curtains and decide if you can wash them in one or more loads. Select the correct

programme for the fabric. If the curtains have not been washed for some time they may be dusty, in which case it is a good idea to rinse them on programme H or T according to the fabric. After draining, start the suitable wash programme.

Dyeing

You can dye fabrics successfully in the machine but it is essential to buy a good proprietary dye and to read the manufacturer's instructions carefully. Make sure that the fabric is suitable. The dye instructions will guide you on this point. Then wash the article to make sure it is thoroughly clean, using programme C or N according to the fabric. Then follow the instructions for machine dyeing.

Immediately after you have removed the dyed material from the machine, set it to programme G to clean all traces of dye from the machine.

It is not absolutely necessary to add washing powder to the dispenser, however you can add it if you prefer.

Stain removal

Some stains will not be removed in the wash. It is wise to treat them before laundering.

The following are simple but effective treatments to use on any washable fabric. Treat the stain as soon as possible and launder afterwards to remove any residual stain.

Ballpoint and felt-tip ink:

Dab with methylated spirit on cotton wool (not on acetate or triacetate fabric).

Fountain pen ink:

Sponge with cold water to flush out as much ink as possible, or hold the fabric under running cold water. Launder and treat any remaining stains with lemon juice.

Grass stains:

Dab with methylated spirit (not on acetate or triacetate). Rinse in clear water.

Oil:

If heavy stains from cycle or car oil do not come out in the wash, treat them with a proprietary grease solvent.

Paint: Emulsion:

Sponge immediately with cold water and then launder. If the stain has dried, soften it with methylated spirit or a proprietary paint brush cleaner. (Test an inconspicuous corner of the fabric first).

Gloss:

Dab with methylated spirit or proprietary paint brush cleaner. (Test fabric first).

Rust (iron mould):

Rub with lemon juice and then sprinkle salt over the stain and leave for an hour. If subsequent washing does not remove the stain, use a proprietary rust cleaner following manufacturer's directions.

Servicing

If, having followed these instructions carefully, your machine fails to work properly, contact your local Zanussi Service Network, giving the full model number and date of purchase if the appliance is under guarantee. Details of your local Zanussi Network Service Centre can be found by looking in the White Pages phone book under Zanussi.

Before you do that, though, it is worth making a few simple checks yourself.

If the machine won't start...

Ensure that the programme control knob on the machine is pulled out into the 'on' position.

Make sure that the door of the machine is firmly shut.

Make sure that the appliance is properly plugged in and that the socket switch (if any) is in the 'on' position.

Check that there is power at the socket by plugging in an appliance you know to be working – a small lamp, for example. If this too fails to work, check the main circuit fuses in your home's consumer unit or main fuse box.

If the machine won't fill...

Make sure that the supply hoses are not kinked.

Make sure that that all water taps are turned on.

Check that there is sufficient water pressure. A way to check this is to place a two gallon bucket under the water

feed pipe to the appliance and turn on the tap(s). The bucket should fill in about one minute.

If the machine won't drain or spin...

Unhook the drain hose from the drain pipe or sink and hold the hose over a bowl on the floor. The water should drain by gravity into the bowl. If the bowl is full, hook the hose back up and empty the bowl. Repeat the procedure until the water has drained from the machine.

Then check that the drain filter in the machine is not clogged.

If the machine empties as it fills...

Make sure the end of the drain hose is not less than 50cm (20") above floor level.

If the machine vibrates badly, or is too noisy...

Check that the machine is absolutely level.

Check that there is sufficient clearance between the machine and wall, furniture, etc.

Check that all the internal packing, plastic spacers and transit security bolts have been removed as described at the start of these instructions.

IN-GUARANTEE CUSTOMERS SHOULD ENSURE THAT THE ABOVE CHECKS HAVE BEEN MADE AS THE ENGINEER WILL MAKE A CHARGE IF THE FAULT IS NOT A MECHANICAL OR ELECTRICAL BREAKDOWN.

*** Please note that proof of purchase is required for any in-guarantee service calls.**

Peace of mind for twelve months

ZANUSSI STANDARD GUARANTEE CONDITIONS

This guarantee is in addition to your statutory and other legal rights which will not be excluded or in any way diminished by the return of this guarantee card.

We, Zanussi Ltd, undertake that if, within twelve months of the date of the purchase, this ZANUSSI appliance or any part thereof is proved to be defective by reason only faulty workmanship or materials, we will, at our option, repair or replace the same FREE OF ANY CHARGE for labour, materials or carriage on condition that:

- The appliance has been correctly installed and used only on the electricity supply stated on the rating plate.
- The appliance has been used for normal domestic purposes only, and in accordance with the manufacturer's operating and maintenance instructions.
- The appliance has not been serviced, maintained, repaired, taken apart or tampered with by any person not authorised by us.
- The appliance is still in the possession of the original purchaser.

All service work under this guarantee must be undertaken by a Zanussi Network Service Centre.

Any appliance or defective part replaced shall become our property.

Exclusions

- Damage or calls resulting from transportation, improper use or neglect, the replacement of any light bulbs or removable parts of glass or plastic.
- Costs incurred for calls to put right machines improperly installed or calls to machines outside the UK and the Republic of Ireland.
- Appliances found to be in use within a commercial environment, plus those which are the subject of rental agreements.

or five years

ZANUSSI 5 YEAR COVER CONDITIONS

For a once-only payment you can extend your Standard Guarantee to 5 years. All the conditions and exclusions of the Standard Guarantee apply.

Notes

1. Products supplied as “seconds”, refurbished, damaged or shop-soiled are not eligible for Zanussi 5 Year Cover.
2. The issue of a cover does NOT by virtue of our having done so, nullify the exclusions.

3. The Engineer will need to check the details of your Cover card and may make a charge for his services if it is not presented to him at the time of his call.
4. The date of purchase, or the date of initial payment (deposit) of the appliance will be deemed the date of commencement of cover.
5. Covers issued are not refundable or transferable.

Guarantee Record

Appliance purchased from _____ on _____
Guarantee card no _____ Model no _____
Serial no _____ (These details may be
Your name _____ taken from your
Address _____ Guarantee Record Card)

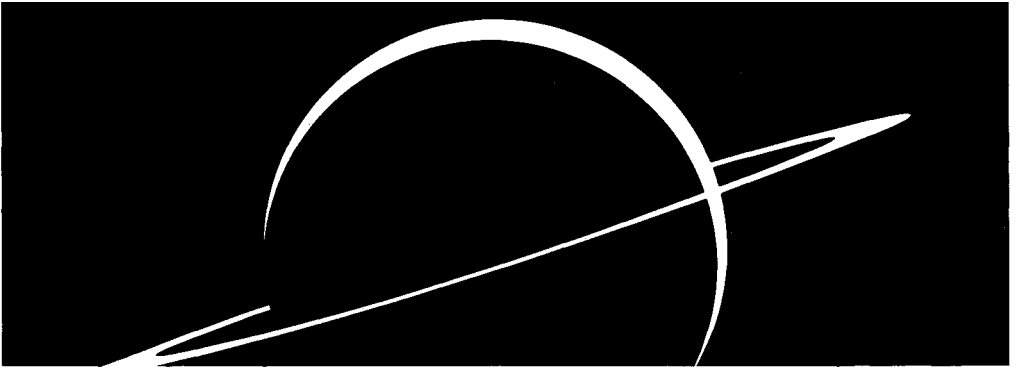

ZANUSSI

The appliance of science

Zanussi Ltd., Zanussi House, Newbury.

The information in this manual is correct at time of going to press.
Zanussi reserve the right to alter specifications without notice.

456789101112/89